

GROUND SUPPORT

WORLDWIDE



Clean Energy



Malabar



Engine Distributors



SCHOPF



J&B



Wasp



Par-Kan



Metro Crown



Liquip International

Industry Showcase 2011

What is the cost of safety?

Not as much as you would think.

Safety on the ramp is very important, whether it's protecting personnel or millions of dollars in aircraft. J&B Aviation has a long history of developing products to do both. From our Thermgard® connectors to our LPCU® Power Service Points we have the knowledge and technology to provide protection while using 400HZ power. Our cable scuff jackets help to prevent strain and injury by making it easier to move ground power cables and the high visibility makes it easier to prevent trips and falls. We also offer safe PCAir products from our high visibility, ultra lightweight SuperHose® to our PCAir reels which reduce back strain while providing a great storage solution for your hoses. J&B Aviation is the leading supplier of ancillary products to the aviation industry.



Make the **RIGHT** connection.

US Toll Free 1.800.621.0074 Phone 1.707.469.2600 Fax 1.707.469.2620
sales@jandbaviation.com www.jandbaviation.com



GROUND SUPPORT WORLDWIDE

PUBLISHER

Missy Zingsheim
920.563.1665 • missy@AviationPros.com

EDITOR

Steve Smith
920.563.1644 • steve.smith@AviationPros.com

SALES

Randy Graper
920.563.1621 • randy.graber@AviationPros.com

Kimberly Jorgensen - Classifieds
920.568-8307 • kimberly@AviationPros.com

Benedict Hume - Sales Manager
+44 1442 288287 • +44 1442 219898
benedict@itsluk.com

Julian Maddocks-Born - Sales Director
+44 1442 288299 • fax +44 1442 219898
julian@itsluk.com

Elizabeth Jackson - List Rental
847.492.1350 ext. 18 • ejackson@meritdirect.com

PRODUCTION & CIRCULATION

Meredith Burger - Art Director
Carmen Seeber - Media Production Rep
920.568.8373 • carmen.seeber@AviationPros.com

Debbie Dumke - Circulation Manager
Steve Swick - Production Director

CYGNUS AVIATION EXPO

Emily Patten - Trade Show Director
847.454.2723 • emily.patten@cygnus.com

Published by



CYGNUS AVIATION

Gloria Cosby - Executive Vice President
Gerry Whitty - VP, Marketing

CYGNUS BUSINESS MEDIA

John French - CEO
Paul Bonaiuto - CFO
Tom Kohn - EVP, Digital
Tom Martin - VP, Manufacturing
Julie Nachtigal - VP, Audience Development
Eric Kammerzelt - VP, Technology
Ed Wood - VP, Human Resources
Rob Brice - SVP, Expo
Curt Pordes - VP, Production Operations

Published and copyrighted 2011 by Cygnus Business Media, 1233 Janesville Ave., Fort Atkinson, WI 53538 USA. All rights reserved. No part of this publication may be reproduced or transmitted in any form or by any means, electronic or mechanical, including photocopy, recording or any information storage or retrieval system, without written permission from the publisher.

Cygnus Reprint Services

To purchase article reprints please contact Foster Printing Services at 1-800-875-3251 or email sales@fosterprinting.com

Subscription Policy: Subscriptions are free to qualified businesses. Others may purchase subscriptions at these rates: US, 1-year \$35, 2-year \$65; Canada & Mexico, 1-year \$50, 2-year \$95; All other countries, via airmail, 1-year \$75, 2-year \$145. Single copies, \$10.

Ground Support Worldwide (USP 015-386, ISSN 1934-2861 print, ISSN 2150-4016 online) is published ten times annually in February, March, April, May, June/July, August, September, October, November and December/January. Periodicals postage paid at Fort Atkinson, WI and additional mailing offices.

Change of address or subscription information: Toll Free - 877-382-9187, Local - 847-559-7598, circ.groundsupportww@omeda.com

POSTMASTER: Please send address changes to Ground Support Worldwide, Cygnus Business Media, P.O. Box 3257, Northbrook, IL 60065-9765. Printed in the U.S.A.

Canada Post PM 40063731. Return undeliverable Canadian addresses to: Ground Support Worldwide, Station A, P.O. Box 54, Windsor, ON N9A 6J5.



Contents

- 4** Editor's Note/Advertiser's Index
- 6** Publisher's Note
- 7** Cargo/Baggage Handling
- 10** Deicing/Anti-icing
- 14** Fuels/Filters/Equipment & Services
- 18** GPUs/Air Starts/PCAs/Parts & Accessories
- 24** Green Products/Alternative Technology
- 26** Ground Handlers & GSE Services
- 29** Maintenance/Shop Equipment
- 37** Passenger Stairs/Lifts/Boarding Bridges
- 39** Pushbacks/Tractors/Utility Vehicles
- 43** Safety/Security/Communications
- 44** Classifieds

- A** Clean Energy
- B** MALABAR
- C** ENGINE DISTRIBUTORS INC.
- D** SCHOPF
- E** JB
- F** Wasp
- G** Par-Kan
- H** METRO
- I** LIQUIP INTERNATIONAL



STEVE SMITH

Thoughts On *inter airport* Europe

The GSE world seems a manageable globe after I came back from my first visit to this major trade expo.

What to take in first after my first tour? Certainly, the sheer size of the exhibit space. Not just two big halls inside, but an outside pavilion just as immense. Having an outdoor exhibit in October in Germany seemed like an iffy proposition to me. Given the nature of GSE, however, the great outdoors is a fitting choice – maybe the only choice for this much variety of equipment. From squat pushbacks to towering deicers to working, full-scale belt loaders, the outdoor pavilion was a great place to learn.



Outside or inside, more than 12,000 visitors from 34 countries visited 606 exhibitors at *inter airport Europe*. Macks Brooks Exhibitions

I was told the industry was a bit short on new products. However, I was barely 30 minutes into the show's first day when I attended a JBT AeroTech press conference introducing four pieces of equipment, including a redesigned B600 making its industry debut. This one certainly had some flair to it with curved wheel wells and a cab that almost looked like any other pickup truck you might see at the local car dealer. Not bad for something that tops out at 15 miles an hour. Throughout

that first day I saw new products from Semmco; Douglas; Harlan and Meggitt.

I've been to plenty of trade shows in my career equally as enormous as *inter airport Europe*, but it never ceases to amaze me how much pride product managers take in describing their products. I introduced myself, for example, to one such manager at Unitron and spent the next hour hearing about plans to grow the European market and why the company's product was a natural to accomplish this.

I know I left with a stack of business cards about three inches thick and introduced myself to plenty of helpful people that will point me in the right direction for story ideas. Along the way, I learned some bad Irish jokes, received a picture of me holding up a three-foot long hot dog that I'd rather not discuss, and, finally, took back a lifelong memory of singing along to John Denver's "Country Roads" – an inexplicably popular German bar song.

In other news, by now I trust my *Ground Support Worldwide* readers are "aviation pros" when it comes to navigating our new aviation portal, www.AviationPros.com. We launched the new site earlier this month. The site leverages our expertise in the aviation industry by combining the online presence of all properties under the Cygnus Aviation umbrella – including *airport business*, *Aircraft Maintenance Technology*, and, of course, *Ground Support Worldwide* magazines. Explore the site and tell us what you think.



Advertiser's Index

Advertiser	Page
A T Juniper	38
AERO Specialties	29
ASIG	20
ASIG (HR Division).....	43
Clean Energy	5
Columbus Jack	22
Cygnus Aviation Expo/SAE.....	34-35
Douglas Equipment.....	40
Engine Distributors Inc.	21
Garsite	31
Global Ground Support	36
Grainger	15
Ground Support Products	33
Hannay Reels	23
Hydraulics International.....	37
J&B Aviation	2
J&J Group.....	25
Lektro	38
Liquip International	48
Mac Heaters.....	43
Malabar.....	19
Metro Crown.....	11
Metroplex Conveyor & Services...	40
Par-Kan Company.....	47
PF Fishpole Hoists	39
Phoenix Metal Products.....	26
Premier Engineering & Manufacturing	24
Rampmaster.....	28
Reelcraft	32
Sage Parts	30
SCHOPF	13
Servicore.....	39
Somerset GSE Finance.....	8
Tapeswitch Corporation	42
ThyssenKrupp Airport Systems ...	27
TIACA	41
U.S. Airmotive GSE	6
Wasp.....	9

Connect to each manufacturer: aviationpros.com/magazine/gsm/enquiry

Editorial Advisory Board

- ASIG - **Yvonne Coleman**
- AeroVironment/PosiCharge - **Ryan Gibson**
- AGERanger.com - **Darryl Clark**
- Aviance - **Alain Chagler**
- Charlotte of America - **Rob Lamb**
- Continental Airlines - **Jody Lonergan**
- Delta Air Lines - **Joe Fuqua**
- Elite Line Services, Inc. - **Dewey Kulzer**
- Fortbrand Services - **Fred DiBenedetto**
- J&B Aviation Services - **David Janis**
- JBT AeroTech - **Jim Cherrett**
Virginia Salas
- NATA-ASC - **Eric Byer**
- Sage Parts - **Michael Bloomfield**
- Triton Technologies LLC - **Debra Guinand**

Your connection to natural gas fueling.

FUELING SERVICES

VEHICLES &
CONVERSIONS

ENGINEERING &
CONSTRUCTION

GRANTS &
FINANCE

COMPRESSORS
& EQUIPMENT

SERVICE & SUPPORT

LNG TECHNOLOGY &
CONSTRUCTION



Clean Energy services — best in class.

We began our business in 1997 by offering our customers complete fueling services with long-term fuel contracts. As the industry has developed, there is greater understanding of natural gas fueling and diversity in implementation.

Today, our Clean Energy Customer Solutions Matrix enables any fleet customer to connect to natural gas fueling through Clean Energy and

succeed no matter what services they seek — from turnkey solutions to equipment-only alternatives.

The Clean Energy Solution, our comprehensive package, provides integrated fueling services: turnkey station engineering/construction, compressors/equipment, service/support and grants/finance with fueling contracts.

Our individual customer solutions provide specific support. Some fleets may want to buy equipment only, or do

their own operations and maintenance or monitoring. No matter. We are here to help you convert to and succeed with natural gas fuel quickly, easily and affordably.

What has not changed is the reason to team with Clean Energy for natural gas fueling — because it's the best decision owners and operators can make to ensure that their vehicle fleets are fueled and roll out every day — on time. In a word — reliability.

Now serving
27 major
airports



Clean Energy[®]

North America's leader in clean transportation

Nasdaq: CLNE
562.493.2804

www.cleanenergyfuels.com

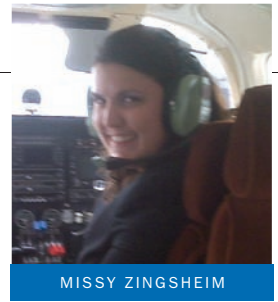

MISSY ZINGSHEIM

Nominate Your Leaders

We'll be honoring the people, products, services and manufacturers that lead the way in the ground support industry during next year's Cygnus Aviation Expo.

It's time to send us your nominations for our *Ground Support Worldwide Leaders of the Year Awards*. We've narrowed the awards down to three:

Lifetime Achievement Award: This award will go to a person who has demonstrated commitment to the industry through numerous years of dedicated service.

Team Leader Award: This award will go to an individual who has taken a leadership role with personnel.

Product/Service Award: New this year, this award celebrates the products, services and manufacturers making a difference in the industry.

The awards will be presented to the winners during a Network Reception, which will also feature our popular truck giveaway, Thursday night, March 8, during next year's Cygnus Aviation Expo in Las Vegas.

Send your nominations to: Missy Zingsheim at missy@AviationPros.com

Please tell us which award you are choosing and include the name of the person, product, service and/or manufacturer you are nominating, as well as your award-winning reasons.

Leaders OF THE Year

Nominate by January 4, 2012

FULLY WELDED PCA HOSE









No Air Leakage

- Reinforced Spiral Wire & Layflat Hose
- Insulated & Non-insulated Products
- Tested To Handle 5 P.S.I.
- UV & Abrasion Resistant Materials
- Various Diameters, Lengths & End Finishes

NEW

MANUFACTURERS OF: AC & DC GROUND POWER STARTING CABLES PER MIL SPEC. MS90328, MS90347, MS25486, MS25488 • PLUGS AND RECEPTACLES AC & DC MS25486, MS25488, MS25487, MS25019, MS90362, MS3506.

HOSES: LAVATORY DRAIN-BLUE & POTABLE WATER-PCA-AIR/HEAT-JET STARTER
COUPLINGS FITTINGS AND CONNECTORS • CASTERS • WHEEL CHOCKS • DAVID CLARK
LAV METERS • PARTS FOR TUG • HOBART • TRILECTRON • PARKAN • FMC • CLYDE

 LAV HOSES AND COUPLERS	 LAV COUPLINGS AND FITTINGS	 WATER HOSES, COUPLINGS AND FITTINGS	 GSE PARTS
 AC/DC CABLE PROTECTOR COVER	 ATTACHABLE PLUGS AND RECEPTACLES	 JET STARTER HOSES AND COUPLINGS	 GSE PRODUCTS

CONVEYOR • BELTS • SAFETY VEST • DIRECTIONAL WAND • TOW BARS • CARGO NETS
STRAPS • TIEDOWN RINGS • MATERIAL HANDLING AND MORE

NEW CRUSH PROOF LAVATORY DUMP HOSE

NEW

You can Run over it, Smash it or Drag it and STILL USE IT!





U.S. AIRMOTIVE GSE
YOUR ONE STOP SOURCE SINCE 1963

FLORIDA MAIN OFFICE
Phone (305) 885-4992
Fax (305) 885-9537
Po Box 660474
Miami Springs, FL 33266
sales@usairmotivegse.com

CALIFORNIA SALES OFFICE
Phone (310) 327-8407
Fax (310) 327-8439
paula@usairmotivegse.com

WWW.USAIRMOTIVEGSE.COM

Cargo/Baggage Handling

CONNECT
TO EACH MANUFACTURER
aviationpros.com/magazine/gsm/enquiry



BATTERIES AND CHARGERS

Douglas Battery & Chargers

Since 1921, Douglas Battery has been providing reliable power to keep your equipment moving. The new Titanium High Frequency Conventional & Opportunity Profile Charger, which is more energy efficient, has the highest power factor, increases the life of the battery, and reduces maintenance costs, is now available in an 80-volt model.



CASTERS

Ground Support Products Corp.

Ground Support Products offers a variety of casters: OEM, forged steel, sealed base-bearing, winged and stair casters. Sealed, double-ball race wheel bearings prevent dirt and debris from obstructing movement of the caster wheel. GSP's 3.5-mm fork is 1/2 mm thicker than most others. Designed specifically for the roughness of the airline industry.

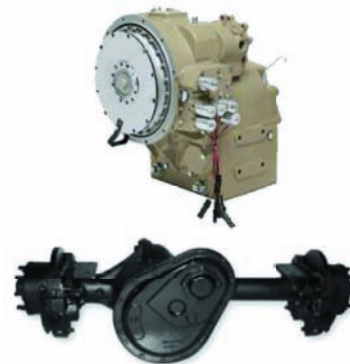

TRANSMISSION AND AXLE REPAIR

Palmer Johnson Power Systems

Palmer Johnson Power Systems operates 10 fully equipped service centers from the Great Lakes to California with 50 experienced, factory-trained technicians and 24/7 on-call service. Palmer Johnson is an authorized service center for Twin Disc, ZF, Funk, Carraro, AxleTech, and other manufacturers of off-highway transmissions, axles and power-train components.



AXLES AND COMPONENTS

Metro Crown International

Metro Crown International is a premier supplier of front steer axles and components to fit most major brands of baggage tractors. MCI manufactures and stocks the components parts and can turn many orders around the same day at a significant cost savings to our customers.



CONVEYOR BAGGAGE CHUTE

R.J. Design LLC

Conveyor Baggage Chute was designed to eliminate shoulder and back injuries for ground personnel. Services aircraft up to a 757 along with all regional aircraft. Adjust to heights and conveyor reverses to load and unload baggage and wheelchairs.



BAGGAGE CART

Par-Kan Company

Par-Kan Company offers open and closed baggage carts as well as a wide variety of GSE equipment, including potable water carts, lavatory carts, fuel service carts, oxygen/nitrogen carts, electric trucks for water and lavatory service.

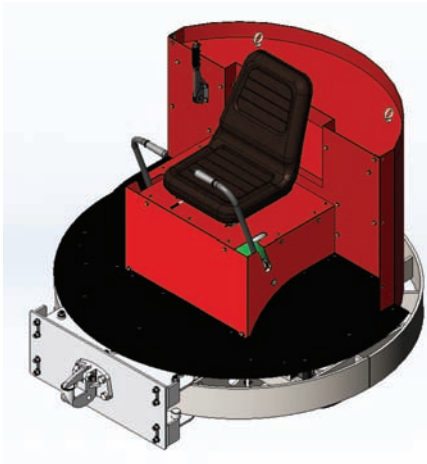

ELECTRIC-POWERED ODV
The Hammonds Companies

Hammonds has announced its newest electric-powered ODV, the G-18E. Rated to tow 18,000 pounds, the tractor is available in electric, engine or with hybrid power. The hybrid model is available with LP, gasoline or diesel engine supplement to the electric drive. The new G-18E has a diameter of only 60 inches making it ideal for crowded manufacturing facilities, crowded hangers and general aviation applications. The ODV's unique omni-directional capability can provide maximum drawbar pull on a variety of surfaces and is available with your choice in either conventional or cutting edge lithium battery power. The G-18E follows Hammonds' introduction of the G-90E to Boeing Aircraft utilizing lithium battery power with the latest in digital controls and power management.



SAFETY BUMPERS
Carson Manufacturing

Carson Safety Bumpers are specifically designed to attach to airline baggage carts, service equipment and service docks to protect aircraft and equipment from accidental scratching or denting which can lead to breaches in the aircraft fuselage. Personnel

are also protected from injury from overhead obstructions and sharp edges. Protect your aircraft and personnel with Carson Safety Bumpers.

GSE MANUFACTURERS REP
Triton Technologies, LLC

Triton Technologies LLC is a manufacturers representative for AeroVironment (PosiCharge battery charging systems), Douglas Battery, Hammonds (Omni-Directional Vehicles and the Fuel Jack) and composite aircraft ULDs.



The Financing Leader for all your Ground Support Equipment needs
 Tractors, Deicers, Loaders, Refueling Vehicles, GPU, Air Conditioners

Rentals • Rent To Own Structures • Long Term Leases

For additional information please contact:
 Bill Long • (973)726-0086 • william.long@somersetcapital.com





Making a
World
of
Difference

Since
1979



GSE Sales: Kevin Hanson
Phone: 320-634-5885; Fax: 320-634-5881
Email: khanson@waspinc.com

Parts & Service: Doug Barsness
Phone: 320-634-5886; Fax: 320-634-5266

Email: dbarsness@waspinc.com; rbeam@waspinc.com

www.waspinc.com

PO Box 249, 20874 State Hwy 55, Glenwood, MN 56334 USA

EOE/AA



Deicing/Anti-icing

CONNECT TO EACH MANUFACTURER
 aviationpros.com/magazine/gsm/einquiry

DAVIES
 Davies TKS Fluid

With our prices this low, it pays for the CATERING!

We accept all Major Credit Cards ISO 9001:2000 Certified

D.W. DAVIES & CO., INC.
 3200 Phillips Ave. Racine, WI 53403
 1-800-888-6133 Fax 262-637-3933

TKS FLUID D.W. Davies & Co. Inc.

TKS Fluid, ADF Type 1 and Type 4, Aircraft Wash and Wax, Safe-Melt Airport Deicer. FAA-approved, both liquid and granular.



HEATED WINDSHIELD WASHER SYSTEM Heatshot Limited

Heatshot provides the only proven, effective, heated fluid windshield washer system, that gives the driver 100 percent visibility, 100 percent of the time. Heatshot's eco-friendly safety enhancement, clears ice, unblocks frozen pipes/nozzles, and eliminates the need to climb to clear the windshield. Heatshot allows a vehicle to be mobile in seconds, reducing holdover times and delays.



GS SERIES DEICERS Ground Support Specialist LLC

GSS manufactures the GS Series 800- and 1,400-gallon deicers on a purpose-built chassis powered by a single engine. The GS Series Deicers are designed for use on a wide range of aircraft.



ORION DEICER Global Ground Support

Global has extended its product range and is introducing a new self-propelled, aircraft deicer model for the regional and executive aircraft market. The new product, called the ORION, is based on the Terex Genie mobile Telehandler powered by a 99-hp Cummins turbo diesel and can be driven and operated from the basket with the operational one-man drive system. It has a working height of 47 feet with a 27-foot forward reach and four-wheel drive and steer for maximum maneuverability. The standard model will be provided with two tanks, the deicing tank for Type I fluid of 700 gallons (2,650 liters) capacity, and an anti-icing Type II or IV tank with a capacity of 180 gallons (681 liters). Different tanks sizes are available for both deicing and anti-icing fluids.



EXPRESS HEAT DEICER Premier Engineering and Manufacturing

Premier Engineering and Manufacturing's Model MT43P21 "Express Heat" Deicer contains 2,100 gallons of fluid storage capacity with 180-degree F fluid within 90 seconds utilizing the "Express Heat" 4.2 million BTU heating system. A double knuckle, telescoping and articulating aerial lift is mounted forward for greater versatility and visibility of the operator. Options include: enclosed basket, single-person drive system, proportioning system, extended reach lift and Guardian Angle Monitoring System for remote access to deicer from hub.



VISCOLITE Hydramotion Ltd

The battery-powered Hydramotion Viscolite® portable viscometer is designed for immediate on-the-spot viscosity measurement with no need for calibration. After the sensor is dipped into the fluid and the viscosity noted, it is quickly rinsed clean.



METRO CROWN INTERNATIONAL
“We Keep You Moving”

“We Keep You Moving”

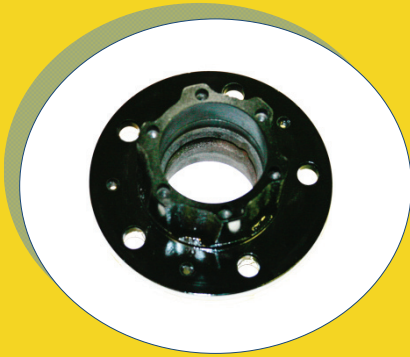

WHEEL HUBS



CONTROLLERS



BRAKE PARTS

**SUPPLYING QUALITY REPLACEMENT PARTS
FOR ALL YOUR EQUIPMENT NEEDS
NEW OR OLD, WE HAVE YOU COVERED**



AxleTech[®]
International
A GENERAL DYNAMICS COMPANY



ORSCHN[®]



Lester  **Electrical** 

**ALL IN STOCK ITEMS SHIPPED SAME DAY
(Order Must Be Placed By 2:00 pm – Central Time)
NO ORDER MINIMUMS**

WWW.METROCROWN.COM

Metro Crown International | Sales@MetroCrown.com
100 SW Scherer Road Lee's Summit, MO 64082
Phone: (816) 525-3900 | Toll Free: (877) 428-4437 | Fax: (816) 525-8878



ICE CONTROL NOZZLES

Task Force Tips Inc.

Task Force Tips' Ice Control Nozzles have been specifically designed to apply water-, glycol-, or water/glycol-based deicing and anti-icing fluids to aircraft exterior surfaces at fluid temperatures up to 210 degrees F (99 degrees C). The proper use of deicing and anti-icing agents aids ground support professionals in the removal of frozen precipitation from aircraft fuselage, landing gear, and wing surfaces and helps prevent ice and snow from adhering to the wings of aircraft.



MOBILE DEICER CARTS

Tronair Inc.

Tronair's Mobile Deicer Carts deliver Type 1 fluid efficiently and effectively. The units come in a variety of voltages to meet your needs. Tronair also manufactures a unit designed specifically for servicing TKS anti-icing fluid reservoirs. The TKS unit is lightweight and easy to use. Tronair's quality, value and service create dependable ground support equipment for customers worldwide.



TRUCK, TRAILER-MOUNTED DEICERS

SDI Aviation

SDI Aviation designs, manufactures, distributes and supports the SUPERIOR® line of truck and trailer-mounted aircraft ground deicers. SDI is continuously striving to improve its product line with innovative features that provide the industry with reliable, efficient and affordable ground service equipment solutions.



NARROW-BODY DEICER

Premier Engineering and Manufacturing

Since 1992, the MT35P75 Express Heat deicer has been the industry standard in low-cost, narrow-body deicing for regional/commuter airlines.



GLYCOL RECOVERY VEHICLE

Global Ground Support

Global Ground Support's Glycol Recovery Vehicle is mounted on an Isuzu NPR HD equipped with automatic transmission, a 5.1-liter engine and 113-liter fuel tank. However, the unit can be mounted on any appropriately sized chassis. The vacuum and hydraulic systems are powered by an auxiliary engine, a Deutz Oil-cooled three-cylinder diesel. This drives a 850-cfm positive displacement blower and provides hydraulic power for the electric over hydraulic controls.



DEICING FLUIDS

The Dow Chemical Company

Dow's UCAR aviation deicing fluids are used in commercial, government, and private aviation for aircraft deicing/anti-icing. Dow offers Type I deicing fluids, Type IV anti-icing fluids, and EG-based runway deicing fluid.

Green Technology!

Emission impossible: SCHOPF F110 electric

Experience the zero-emission innovation from SCHOPF. The world's best-selling aircraft tow tractor is now available in an electric version.

Zero push-back emissions combined with 60 kW of constant power and 95 kN of Drawbar Pull - more than enough for a full day's operations.



ZER
EMISSI
ONS!

SCHOPF

Tractors. Loaders. Stairs. And more.

Quick off the mark!

ROFAN Hybrid + PowerHybrid vehicles

Profit from the flexibility hybrid vehicles bring.

Switch from a powerful diesel engine outdoors to emission-free electric drive indoors. Baggage and freight handling doesn't get easier than this!



ROfan

Made in Germany

■ Hybrid

■ PowerHybrid

□ Diesel

■ Electric

■ GasFuel



SCHOPF Maschinenbau GmbH

www.schopf-gse.com • schopfsale@schopf-gse.com
Parkstrasse 19-21 • D-73760 Ostfildern/Germany • Phone +49 (0) 7 11 3 40 00-0 • Fax +49 (0) 7 11 3 41 10 87

SCHOPF ROFAN GmbH

www.schopf-rofan.com • info@schopf-rofan.com

Fuels/Filters/ Equipment & Services

**CONNECT
TO EACH MANUFACTURER**
aviationpros.com/magazine/gsm/einquiry



NATURAL GAS FUELING STATIONS Clean Energy

As the leading provider of natural gas fuel and related services in North America — now serving 27 airports — Clean Energy designs, builds, operates and main-

tains fueling stations; provides natural gas fuel on long-term contract; helps secure financing and vehicle grants. Our comprehensive, turnkey solution supports low-cost, state-of-the-art, sustainable fleet operations.



RAMPMASTER ENGINE MANAGEMENT SYSTEM Rampmaster

Rampmaster's patented Engine Management System features engine-controlled pump modules that reduce engine rpm - saving fuel and emissions. No more complex venturi or control valves to purchase or maintain. Fuel economy up 40 percent. Engine wear down 46 percent. Save more than \$8,700 on annual fuel purchases (based on \$5/gallon).

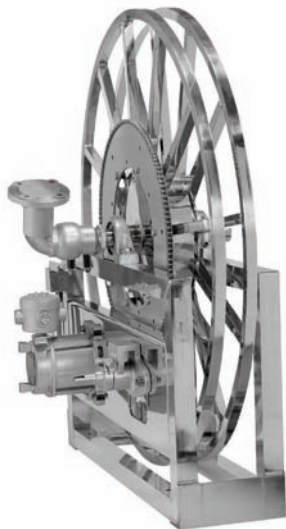

SINGLE WRAP REEL Hannay Reels Inc.

The Hannay 5000 Series single wrap reel features a strong, heavy-duty design to accommodate the longer lengths of large hose used in aviation fueling. The narrow, single wrap design provides quick and easy rewinding, wrapping, and guiding of hose normally difficult to handle.



FUEL AND FLUID WARMING SYSTEM Arctic Fox LLC

Hydraulic- and fuel-heating components and systems for trucks and equipment that are powered by vehicle's electrical power or cooling system.



GROUND SERVICE PUMPS The Gorman-Rupp Company

Gorman-Rupp offers a complete line of ground service pumps and related equipment, consisting of several standard centrifugal and self-priming pump models, directional valves, educators and a host of other piping accessories.



STAINLESS STEEL INNER LININGS Garsite/Progress LLC

Garsite has introduced stainless steel inner linings on double-wall tanks. While improving longevity and operational reliability, Garsite eliminates the epoxy coating and replaces it with a stainless steel inner tank, at the same cost to the customer. Replacing the carbon steel, epoxy-coated inner tanks with a stainless steel inner tank will add years of uninterrupted service to the life of an above-ground fueling system.



Over 900,000 products for the ones who get it done.
Call. Click. Stop By. www.grainger.com

GRAINGER
FOR THE ONES WHO GET IT DONE



FULL-LINE FUELING COMPANY

Titan Aviation

Titan Aviation is a manufacturer of refuelers, hydrant dispensers, hydrant carts, fuel farms, hydrant pit cleaners. Titan Aviation also does commissioning as well as preventive maintenance.



SOLE SHELL BRAND SUPPLIER

Eastern Aviation Fuels, Inc./Shell Aviation

Eastern Aviation Fuels is the sole provider of Shell-branded aviation fuel in the United States.

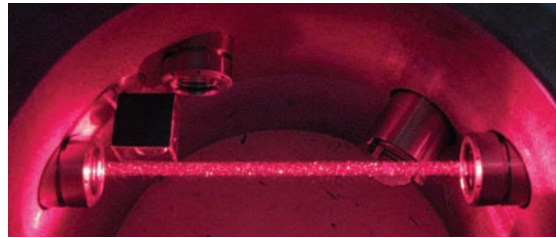

VCA® VELCON CONTAMINANT ANALYZER
Velcon Filters Inc.

The VCA® uses laser sensing technology to act as a final stage

quality check downstream of the last filtration, to insure that the fuel being loaded onto commercial airliners is clean and dry. In the event of wet or dirty fuel (or both), the system will shut down the fueling operation and alert the user with a minimal amount of contaminated fuel reaching the plane.



FUEL EQUIPMENT DISTRIBUTOR

Source International Ltd.

We are an authorized distributor/reseller for fueling equipment including Cla-Val Co., Cavotec - Meyenrinck Pantographs, Cavotec - Dabico Pits, LC Meters, Mueller Strainers and various DBBV Plugs, Ball Valves & Flow switches.



FLOW COMPUTER
Total Control Systems

The TCS3000 electronic register is a fully integrated flow computer that controls all fuel delivery operations. Featuring a large color VGA screen, a backlit alpha-numeric keypad and open printer interface for simple fueling deliveries.



RAMPCHARGER
Bosserman Aviation Equipment Inc.

Bosserman Aviation Equipment, Inc. introduces the Rampcharger, an electrically driven Isuzu refueler, ramp and hydrant servicer. The RampCharger is environmentally green (no gasoline or diesel engine), yet offers the amenities of a standard, factory-warranted chassis.

INTRODUCING THE ALL NEW AVIATIONPROS.COM



**KEEP INFORMED
AND CONNECTED
LIKE NEVER BEFORE**

The official website for *Aircraft Maintenance Technology*, *Airport Business*, and *Ground Support Worldwide*.

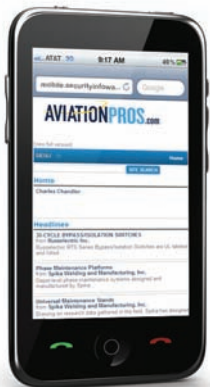

RE-DESIGNED LOOK & FEEL

Now easier than ever to navigate throughout the site:

- Find breaking news with new Most Popular Stories list
- Enhanced social media connection to Facebook, Twitter and LinkedIn
- Access optimized mobile version on your smart phone

STAY CONNECTED TO THE AVIATION INDUSTRY

Gain access to even more NEW features:

- Find breaking industry news and information
- Fast and easy sign up for industry newsletters
- Comment on articles and blogs
- Review products and services in the Buyer's Guide



CHECK OUT THE ALL NEW AVIATIONPROS.COM TODAY!

AVIATIONPROS.com



Part of the Cygnus Business Media Family.

GPUs/Air Starts/ PCAs/Parts & Accessories

**CONNECT
TO EACH MANUFACTURER**
aviationpros.com/magazine/gsm/einquiry



**MAC MODEL 400HC
PORTABLE, INDIRECT-FIRED,
AIRCRAFT HEATER**
MAC Heaters

MAC offers three indirect-fired, portable aircraft heater models, ranging from 200,000 to 800,000 BTUs. Effectively heats all types of aircraft in the coldest, most difficult conditions. Replaces APUs for aircraft heating for substantial avoided fuel burn savings. Simple to operate, environmentally friendly, safe, ruggedly dependable, and very efficient.



ALTERNATE POWER BUS
Unitron

Unitron, LP introduces the N+1/ Hot-swap Alternate Power Bus for airborne applications. Utilizing the TSO Authorized GS-94-444-22 series frequency converters in combination with a Paralleling Control Box, Unitron LP debuts a system that can be programmed to provide alternate 50/60/400Hz power running from variable 400Hz aircraft power.



JETGO GPUS
AERO Specialties

JetGo GPUs have been specifically designed to meet the increasing demand in the aviation industry for a quieter yet powerful “green” ground power unit. Its design promises to set a new standard for 28-volt DC ground power units.



MODEL 3300 GPU SERIES
**Start Pac/Rotorcraft
Enterprises LLC**

Start Pac 3300 GPU series range from 24- to 28-volt starting units. These are custom designed to meet individual requirements so that the customer only pays for what they need. Some of the 3300 series are for starting only and others are for starting and powering up aircraft systems with either a 105- or 175-amp power supply.



**MODULAR GROUND
POWER PLUG**
**J&B Aviation Services - An ITW
GSE Group Company**

J&B Aviation Services’ modular 400Hz ground power cable, JB9516, provides the optimum in design and customer options. The streamlined connector provides greater versatility for today’s use as well as tomorrow’s requirements. High-visibility replacement contact section allows for in-field replacement in just 3-5 minutes. Molded tapered strain relief at connector back strengthens connector by absorbing the “whip-saw” action commonly used when inserting and removing connector from the aircraft. Lightweight and cost-effective.



ULTRALYTE DUCTING
ABC Industries Inc.

ABC Industries Inc.’s complete line of premium PCA ducting products offers superior performance and construction to the airline industry. UltraLyte ducting is the most abrasion-resistant, lightweight PCA ducting available today. Other product lines include Economy, FloVent™, and FloFlex™ blower tubing for a variety of PCA applications.

A World Leader in B787 Coolant Service Equipment



Malabar's B787 Coolant Service Cart (CSC) is approved by Boeing for Environmental Control Systems service. Equipped with an integral programmable logic controller, the CSC performs rapid aircraft coolant drain, fill, clean and de-aerate operations.



Malabar's B787 Coolant Top-Off Pack (CTOP) is a portable, convenient unit approved by Boeing for line maintenance fill and drain service.



Serving the worldwide aviation ground support industry for 75 years, Malabar's Quality Management System is certified to ISO 9001:2008.

www.malabar.com

220 W. Los Angeles Avenue • Simi Valley, CA 93065 USA • 1-805-581-1200 • pam@malabar.com



PCA HOSE TROLLEY
Metroplex Conveyor & Services

One hundred percent stainless steel hose trolleys secure rigid or layflat ducting that allows fast and easy deployment and storage while dramatically extending hose life. Trolleys mount to loading bridges and are modular in design, allowing them to be configured with varying reach for different aircraft depending on gate requirements.



CONFIGURABLE COMBINATION CART
ITW Military GSE

ITW Military GSE's JO3C (Joint Operations Configurable Combination Cart) provides power and air to multiple aircraft platforms. It follows a modular design concept that allows flexibility to select required cooling and power outputs for multiple aircraft platforms. Power modules can be removed and used as stand-alone units. Options include 400 Hz converter, 270 VDC converter, 28 VDC converter, servo air, diesel or electric powered (or both) and a lighting package. The power quality exceeds MIL-STD-704E and F-35 standards. The unit is transportable on a single C-130 pallet position.

Safe & Reliable. Even When the Weather Isn't!

When the temperature drops and winter weather is at its worst, extra steps must be taken to ensure the safety of your aircraft and passengers. ASIG has decades of experience in providing deicing services at airports that endure severe weather conditions. We offer the most advanced snow removal technology and have invested heavily in a state-of-the-art deicing fleet. In addition, rigorous safety programs and realistic simulator training allow our deicing specialists to consistently provide safe and reliable service.

407.648.7373 | www.asig.com
Aircraft Deicing | Fluid Management

EXCEPTIONAL
SERVICE FROM THE GROUND UP



ASIG
AIRCRAFT SERVICE INTERNATIONAL GROUP®

BBA Aviation

©2011 ASIG



GROUND POWER UNITS
Current Power LLC

Current Power LLC is a leading manufacturer of 28-volt DC power supplies for corporate, military, and commercial customers. The company is known most for its 600- and 400-amp mobile units, these units provide 2,000 and 1,200-amp peak starting current and its exclusive re-connectable input which makes a single model useable around the world, on any 50 or 60 Hz power. The photo shows the company's best selling unit, the MSR-600.

Go Green

With Ford Advanced Technology Engines.

A Green Alternative to Diesel from



YOUR Tier IV Solution

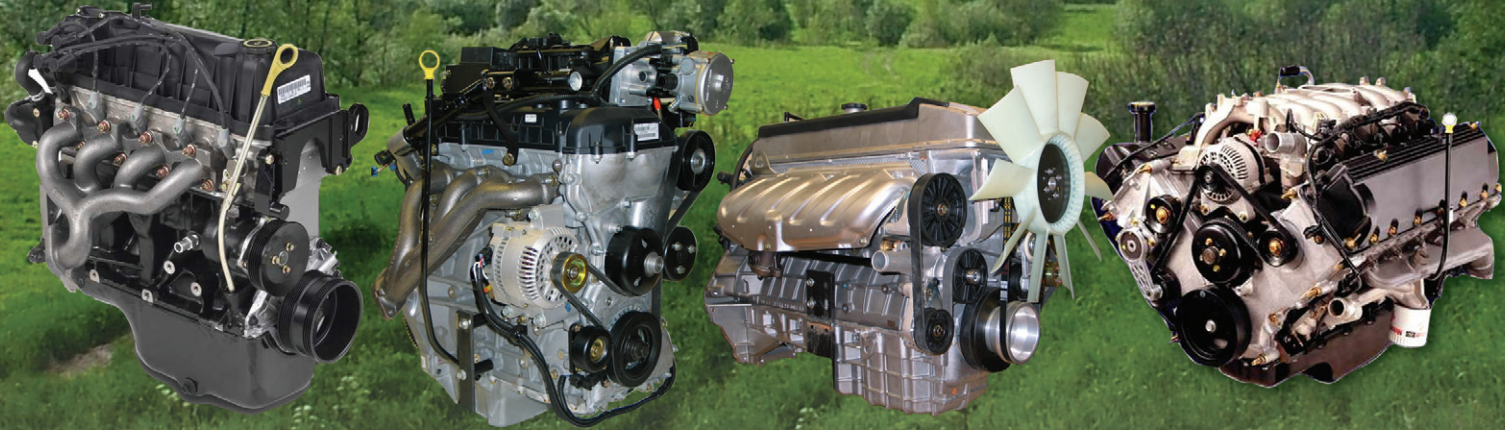

Reliable — Durable — Clean — Green.

Featuring a complete line of EPA and CARB Certified 1.6, 2.3, 4.0, and 6.8 L LSI Engines ranging from 20 to 200 hp. Available in Gasoline, LPG, CNG, Natural Gas and Dual Fuel. Our engines are the solution to high priced Tier 4 Diesels. Secured Volumes, Longer Life Cycles, Dry Fuel and Flex Fuel Valve Trains – You Can Find It At EDI. Performance you can count on!

Contact One Of Our Distributors Today!

Our line of LSI industrialized Ford engines are serviced through a Global Dealer Network.

Anderson Industrial Engines Co.
Omaha, NE 402-558-8700

Southwest Products Corp.
Phoenix, AZ 877-779-3581

Diesel Power Equipment
Chicago, IL 877-876-3732
Farmington, MO 800-876-3732

Engine Distributors Inc.
Archdale, NC 800-220-7080
Blackwood, NJ 800-220-2700
Ft Lauderdale, FL 800-257-6605
Holliston, MA 800-220-2700
Jacksonville, FL 800-342-3575

Engines, Inc.
Jonesboro, AR 800-562-8049

Powertech Engines Inc.
Fresno, CA (800) 750-1776
Fullerton, CA (800) 784-1776

McDonald Equipment Co.
Willoughby, OH 800-589-9025
Portland, MI 800-445-5273

**M. G. Bryan
Equipment Co.**
Grand Prairie, TX
972-623-4300

Pacific Torque LLC
Seattle, WA 206-241-8300

**D A C Industrial
Engines Inc.**
Dartmouth, NS, Canada
902-468-3765

M K Power Products Corp.
Mississauga, ON, Canada
905-890-5323

Simson Maxwell
Edmonton, AB, Canada
800-374-6766
Calgary, AB, Canada
800-374-6766
Port Coquitlam, BC, Canada
800-374-6766

Nanaimo, BC, Canada
800-374-6766
Prince George, BC, Canada
800-374-6766

All Marine Spares
Mona Vale, N.S.W., Australia
61-2-99972788

Compagnia Tecnica Motori S.p.A.
Milano, Italy
+39 0245058238

Fornaut Ehm Sa
Le Pre St Gervais, France
01133148450394

Marindustriel
Montréal, QC, Canada
514-342-2748

Power Torque Engineering Ltd
Binley, Coventry, UK
011-44-247-663-5757

Sauer Motive Systems
Sauer and Sohn KG
Dieburg, Germany
011-49-607-120-6330

Engine Distributors Inc. • 400 University Court • Blackwood, NJ 0812-3214
Phone: (856) 228-7298 or (800) 220-2700 • www.edi-dist.com

SEE DIRECTLINK @ WWW.DIESELPROGRESS.COM



QUICK CONNECT - AIR CONNECTOR MCM Engineering Inc.

The MCM Engineering Quick Connect Air Connector does not require tools for connection to be made and installation is less than 1 minute. The QC-AC has a patented technology that eliminates the need for hose clamps. Made with a clear polyurethane material the QC-AC fitting is cleaner, safer and lasts much longer than standard fabric and hose clamp. The 8-inch side of the QC-AC reducer has the BFM Fitting patented connection and the 14-inch side can be ordered with the Universal Zipper/Velcro or Velcro only to match the PCA duct being used by the end-user.

WE CAN COVER ALL YOUR GROUND SUPPORT NEEDS



1.



2.



3.



4.

Equipment :

1. **Model 715J1000EX**
Explosion Proof Bead Breaker
2. **Model 9092-015**
Wheel and Brake Dolly
3. **Model 2295-10PR**
95 Ton Axle Jack
4. **Model 1504-50**
15 Ton Hand Carry Axle Jack



ISO 9001:2008

ColumbusJACK / Regent "The Strength of Experience"

2222 S. Third St., Columbus OH 43207
Ph: (614) 443-7492 Fax: (614) 444-9337

sales@columbusjack.com ■ www.columbusjack.com

Visit complete product catalog on our website.

HALL INDUSTRIES, INC. 314 Mecklen Lane, Ellwood City, PA 16117 Ground Support Equipment PCA 8" Air Adapter/Connector



- Hall Part Number # EA-8980
US PATENT NO. 6289949
& Other Patents Pending
- Excellent Slot Filling Latch
 - Fits ATA Standard Flange
 - Rotary Cam Action Latch Handles
 - Fewer Moving Parts
 - No Linkage, Springs or Bolts Exposed
 - Eliminates potential of FOD
 - Molded EPDM Gasket 25-30 Durometer
 - Light Weight, Less Than 5 Pounds
 - Protects Duct from Getting Damaged
 - Powder Coated
 - 1-year Warranty on Latch Handle Casting



The word "LOCK" is cast into the handles. Provides added safety as ramp service staff can check the locked position.

These adapters are the easiest in the market to rehub. Some major airlines rehub on the line with these parts.

Hall Part #8980-2-100K: Handle Housing Replacement (7 in Right or Left, Includes 2 Bolts, 2 Nut Lock Washer Sets and Rubber Grip Handle)

Hall Part # 8980-2-200: Base Ring Assembly with Gasket (Includes the Gasket attached to a nut)

When our customers complete the rehub on the line, it takes about 10 minutes and avoids the need to take the unit out of service and back to the shop. However, they also are easy to rehub in the shop.

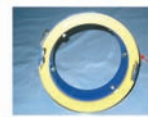

New Stainless steel screen inserts to keep debris from entering aircraft. Molded EPDM Gasket that has proven to last up to 24 months.



Contact: Hall Industries, Inc. Phone (724) 752-2000 FAX (724) 758-1558 e-mail phihk@hallindustries.com
Contact personnel: Perry Shirk, Scott Kennedy or Mark Hall
These units can be ordered by Phone, FAX or e-mail. Hall Industries accepts Visa or MasterCard.

PCA 8-INCH AIR ADAPTER/CONNECTOR Hall Industries, Inc.

- Excellent Slot Filling Latch.
- Fits ATA Standard Flange.
- Rotary Cam Action Latch Handles.
- Fewer Moving Parts.
- No Linkage, Springs or Bolts Exposed.
- Eliminates Potential of FOD.
- Molded EPDM Gasket 25-30 Durometer.
- Light Weight, Less Than 5 Pounds.
- Protects Duct from Getting Damaged.
- Powder Coated.
- 1-year Warranty on Latch Handle Casting.



NEXT GEN PAC Trilectron/Air-a-plane

Trilectron/Air-a-plane introduces the next generation of preconditioned air units: DAC320 Series PC Air. Units are equipped with high-efficiency, zero ozone-depleting refrigerant to cool any aircraft type under the most demanding conditions. The design allows flexibility to use in fixed or mobile applications. The units are available in various sizes to provide the optimal delivered air temperature, volume and static pressure to cool or heat any commercial aircraft.



JB360 SWIVEL AIRCRAFT ADAPTER J&B Aviation Services - An ITW GSE Group Company

J&B Aviation Services' JB360 Swivel Aircraft Adapter for heating and air-conditioning uses the latest advances in composite technology in the seamless fabrication of the Swivel PCA Adapter components. This product is UV-resistant and designed to withstand chemicals, fuels and solvents generally found in the harsh ramp environment. The PCA connection system features rugged construction and lightweight design.

JETEX 6D GROUND POWER Hobart Ground Power

The JetEx 6D is equipped with a Cummins QSB4.5 diesel engine that is fully emission-certified (EPA Tier 3). It is 20 percent more fuel efficient, includes a 35-gallon fuel tank, and provides more than 12 hours of operation on one tank of fuel. The JetEx 6D supports all DC aircraft.



Only one reel takes your crew to a higher level.

In the hangar or on the field, for fueling, repair or maintenance, Hannay Reels provide the efficiency and rugged dependability you demand.

- Top choice of more OEMs
- Heavy duty design and construction
- Sensing and grounding applications
- Hydrant or mobile refueling
- Complete custom capabilities

Hannay Reels deliver confidence by standing up to the most demanding jobs and providing lifetime value – proving that you can't buy a better reel. To find yours, go to www.hannay.com.



Hannay Reels®
The reel leader.

www.hannay.com • 518-797-3791

Green Products/ Alternative Technology

**CONNECT
TO EACH MANUFACTURER**
aviationpros.com/magazine/gsm/einquiry



**MODEL MT65P21
"EXPRESS HEAT" DEICER**

The "Premier" Model MT65P21 "Express Heat" Deicer utilizes the Versalift Extended Reach Model VST6000 Aerial lift, providing 65' of working height. More important, the MT65P21 incorporates the Premier boom forward design to provide the maximum amount of reach off the front of the vehicle utilizing the rapid deploy down riggers. During mobile operations, side reach of 34' and vertical reach of 46' can easily be accomplished.

Premier
ENGINEERING & MANUFACTURING, INC.
Simple, Dependable and Affordable

"Express Heat" reliability, easy access maintenance, extend reach capabilities, and lowest cost of operation is why we are the "Premier" deicer manufacturer.

Tel - 715-735-6440, www.premier-deicers.com



THE ENFORCER CHARGER Allen Energy

The Enforcer Charger by EnerSys operates on existing 400Hz power. Available "onboard" your GSE vehicle so there is no need for expensive electrical infrastructure or stand-alone chargers. Fast opportunity charge mode available.



ELECTRIC HYDRANT DISPENSERS Liquip International/ Beta Fluid Systems

Liquip International's ALL-ELECTRIC Hydrant Dispensers offer the efficiency and safety of our standard vehicle, but with the significant difference of having the diesel engine replaced by a 96VDC battery-powered motor and ancillary drives. Solar panel provides continuous battery top-up all day.



**QUICK COUPLER
'QC' DRAIN PLUGS**
CAP Oil Change Systems, LLC

Allows safe, clean and green oil changes by replacing the original oil pan drain plug with our "QC" spring-loaded, o-ring-sealed drain valve. Eliminates spills, burns and stripped threads.



ELECTRIC PUSHBACK
AERO Specialties

The Eagle Tug eXL-16 electric drive aircraft pushback tractor features all-wheel drive and all-wheel steering. This zero-emission electric drive train, front-operated unit with seating for two passengers is backed by an industry-leading 3-year/3,000-hour warranty. The sleek, environmentally friendly design and careful attention to detail will make this tow tractor a necessity for FBOs, MROs, regional and commercial air carriers.



TIER IV SOLUTION
Engine Distributors Inc.

Featuring a complete line of EPA- and CARB-certified 1.5, 2.3, 4.0 and 6.8 LSI engines ranging from 20- to 200-hp. Available in gasoline, LPG, CNG, natural gas and dual fuel. Our engines are the solution to high-priced Tier IV diesels.



Leading Chinese Manufacturer of Aircraft GSE

www.jjgroup.com.cn

sales@jjgroup.com.cn

Tel: +86-755-33356799

Fax: +86-755-86215111

European Quality Lower Prices CE Certificated Self-Propelled Type

4 Factories 740,000 sq.m. 1,000 Employees



We welcome your enquiries & we are also recruiting sales agents!



Ground Handlers & GSE Services

CONNECT TO EACH MANUFACTURER
 aviationpros.com/magazine/gsm/enquiry



**FULL-LINE GSE
 Tronair Inc.**

Tronair products include: towbars; electric towbarless tugs ranging in capacity from 30,000 to 100,000 pounds; electric baggage/tow tractors; tripod and axle jacks; tail, work and engine stands; engine slings;

compressor washers; hydraulic power units; ground power units; air start units; ram air turbine (RAT) test equipment; fluid service units; deicers; lavatory and potable water service units; air-conditioning and pre-conditioned air units; nitrogen and oxygen transport carts; landing gear service and much more.

"More than you Expected"



MANUFACTURERS OF:

Lavatory trucks & carts

Water trucks & carts

Passenger stairs from RJ to wide body

Crew stairs

Maintenance lifts 15-20 feet

Water cabinets

737 Provisioning Trucks

Mobile Belt Loader

CELEBRATING OUR 16TH YEAR!



LEASING AND FINANCING SERVICES

Fortbrand Services Inc.

Fortbrand Services has been in the business of leasing, financing, renting, maintaining and dealing in aircraft ground support and refueling equipment for more than two decades. The company uses its experience and expertise to provide tailor-made programs to meet the specific requirements of its customers. Fortbrand Services also engages in related activities, including equipment appraisals, consulting, installation of specialized airport facilities projects, as well as acting as a distributor for the sale and lease of unique airfield maintenance equipment.



**3000 Industrial Avenue 3,
 Fort Pierce, FL 34946**
Phone: 772-595-6386 Fax: 772-595-6389
Email: phoenixgse@earthlink.net
Web: www.phoenixgse.com



AVIATION SERVICES - ASIG
ASIG (Aircraft Service International Group)

ASIG is one of the largest independent aviation services companies in the world with substantial operations in over 65 cities throughout North America, Europe and Asia. For more than 55 years, the company has been providing ground handling, fueling, passenger, cargo, deicing, and airport facility services to commercial airlines and airports around the globe.



FUELING COUPLER
Eaton Aerospace Group

Eaton's Model 64910/64810 coupler's lower half have been completely redesigned. Incorporating three detent pins, an internal collar locking device and new collar lifting handle, this new design provides improved ergonomics and operational handling during disconnect.



HIGH VISIBILITY CHOCKS
PACTS, Inc.

Pacific Air Cargo Transfer Systems, Inc., (PACTS) manufactures and distributes ergonomic GSE safety products. The patented designs of our high-visibility Ergo-Chocks weigh 50 percent lighter per square inch as compared to traditional solid rubber chocks. This helps reduce injury and risks; and improve productivity with enhanced product functionality.

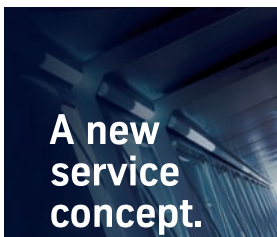

Customized Solutions
Preventive Services
 - Scheduled Preventive Maintenance Programs - All Brands of PBBs & Baggage Handling Systems
 - Safety Inspections
 - Maintenance of Ancillary Equipment: 400 Hz, PCA, Potable Water, Baggage Lifts, etc.
Emergency Repairs & Troubleshooting on All Manufacturer's Equipment
Refurbishment - All Brands of PBBs & Baggage Handling Systems
Integration of Ancillary Equipment
GSE Remote Monitoring Software Design and Installation
Spare Parts & Logistics Management
Operator & Maintenance Training
Airport Consulting, Asset Assessment & Project Management
Layout & Technical Support
Warranty Management

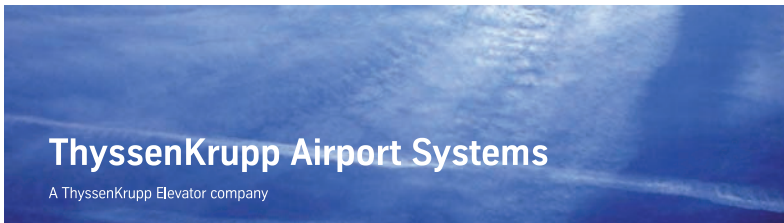
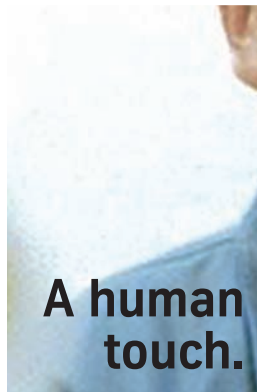



**REPLACEMENT
GSE PARTS
Sage Parts Inc.**

Sage Parts is the world's leading supplier of replacement parts and solutions for GSE. Sage distributes a broad spectrum of services and immediately-available products, ranging from automotive to GSE-specific products, at an exceptional value to its customers. Sage has on-site inventory locations at airports throughout the world, resulting in reduced GSE downtime. Sage Parts

helps its customers operate their businesses more efficiently by offering impeccable service and cost-effective quality products.



**SALES, RENTALS AND TRAINING
Servicore G.S. Corp.**

SGS provides sales, rentals, parts, safety and ramp accessories, technical support, and training for GSE.



**LOW LIGHT VISIBILITY
PolyBrite International**

Products are ideal for low light and nighttime visibility for professional and recreational use. PolyBrite Lighted Safety products include lighted batons, lighted magnetic base batons and tag lights. Together these PolyBrite products offer enhanced visibility for airport crews, traffic control, construction work, police, EMS, rescue and military.

THE RAMPMASTER VALUE PROPOSITION

Engine Management

**EPA emission drops - 63%!
Fuel economy up - 40%!
Lifecycle PV savings – \$99,425!**

Refueling per truck, compared to competition

- No Regulators*
- No Control Valves*
- No Venturi*
- No Servos*
- No Sense Lines*



*New 2011 Engine
Engine Management System (EMS)*

**Rampmaster Coatesville PA. 610-857-1900
www.rampmasters.com**

RAMPMASTER "THE LOWEST COST" AIRCRAFT FUELING SOLUTION



**GROUND SUPPORT
EQUIPMENT
Davin Inc.**

Davin Inc offers sales, rentals, and leasing of new and used GSE. We do equipment appraisals. We will buy your used equipment, and accept trade-in on equipment purchases.

Maintenance/ Shop Equipment

**CONNECT
TO EACH MANUFACTURER**
aviationpros.com/magazine/gsm/einquiry



WHEEL AND BRAKE DOLLY ColumbusJACK/Regent

The wheel and brake dolly - with a 750-pound capacity - is used worldwide by most major airlines, making wheel changes a one-person operation. It is a portable, self-contained unit capable of handling and transporting either a wheel/tire or brake assembly during the removal from or installation on an aircraft. A single-speed, hand-operated hydraulic jack is centrally located on the dolly structure to provide vertical lift. A release valve is provided on the jack for lowering the dolly. Our wheel and brake dolly is built to withstand harsh environmental conditions, rugged use and to provide many years of continuous service.



COMPRESSOR WASH RIG A.T. Juniper (Liverpool), Ltd.

The 2x25 gallon engine compressor washing rig is the mainstay of the Juniper range. Versatile enough to tackle most engines when partnered with our growing list of wash probes, lances and spray rings, yet maneuverable enough for the remotest areas of an airfield.



AIR DATA TEST SET DMA-Aero

DMA-Aero Air Data tester MPS43. Fully autocontrol control. RVSM accuracy. 12 months recall. Ultra-compact size. Highly portable, rugged, only 9 pounds, 12 x 10 x 5 inches, carry-on size giving maximum portability.



FLOW METERS Liquid Controls Group

Flow meters, LectroCount LCR electronic registers and accessories.

Single-Source GSE

If you need it, we have it

AERO has all of the right equipment for your ramp or hangar.
Make it easy on yourself – call the pros that know!

**AERO
SPECIALTIES**
GROUND SUPPORT EQUIPMENT

CE | +1 208-378-9888 | www.aerospecialties.com



BIFOLD DOORS WITH 'LIFT STRAPS'
Schweiss Bifold Doors

Schweiss Doors is raising the standard in the hydraulic and bifold door industry. Truly custom doors are the Schweiss Doors' specialty. We offer two styles of doors that are custom-built for each order. This gives customers total freedom to make their architectural visions come to life. There are no rules, no limitations to what you can do. You think it, We build it!



NEW SIDE-MOUNT HOSE REELS
Reelcraft Industries Inc.

Reelcraft's Series 4000, 5000 and 5005 reels yield great strength from a compact, space-saving design. The addition of a rigid side-mount allows reels to be mounted on either the right- or left-hand side. The heavy gauge side mount plate has slotted mounting holes for easy installation. Reels can be ordered in right (top wind) or left (bottom wind) configuration or easily converted afterward.



ENGINE ACCESS (J) STAND
Liftsafe Engineering & Service Group Inc.

The Engine Access Stand is designed to access the top of most wide-body aircraft engines under the cowl. The pitch and height are adjustable and utilizes anti-fatigue and anti-slip ladder rungs for your safety.

Multiple choice, single source.



Breadth of line, peace of mind.

Sage Parts has the world's largest on-hand inventory of replacement parts for your entire ground fleet. Which means you can put your mind at ease knowing we're your single source for virtually any part you need. From filters, switches, radiators and transmissions to hoses, PCA ducting, couplings and everything in between. Looking for a supplier who can provide any part for every GSE brand? The choice is simple. Sage Parts. Contact us today.



Anticipating needs, meeting demands. Reducing costs.

U.S. and Canada Toll Free 877-SAGE-877
 International +1-631-501-1300 • Fax 1-631-501-1619
 email: info@sageparts.com • www.sageparts.com

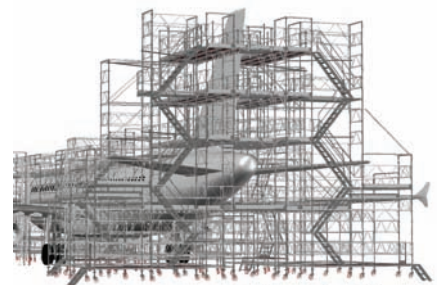

Previous Contract Example

AIRCRAFT DOCKING SYSTEM
Turner Access Ltd. (Aircraft Docking Division)

High quality materials offering strength, speed, mobility and versatility are combined with support in design to suit each client's individual requirements. Training and technical advice are also available. Turner Access Aircraft Docking Systems have numerous benefits for companies in the aircraft maintenance, repair and overhaul (MRO) sector.



VERTICAL-TANK STATIONARY COMPRESSORS
Jenny Products Inc.

Jenny Products, Inc., a long-time manufacturer of portable and stationary compressors, offers a line of electric two-stage, vertical-tank stationary air compressors. Especially suited for applications requiring greater pressure, the two-stage models provide 175 psi and displace between 9.1 and 43.6 cfm.



AUTO AND TRUCK LIFT
Mohawk Resources, Ltd.

Mohawk Lift's introduces a new TR-30 four-post 30,000-pound capacity auto and truck lift. Mohawk's TR-30 features all position safety locks, pivoting approach ramps, and a 6-foot 11-inch lifting height. Mohawk's TR-30 is ALI/ETL-certified to meet the one and only nationally recognized safety standard for vehicle lifts. The Mohawk TR-30 is proudly designed, welded, and manufactured in the U.S.A.



MAINTENANCE HOISTS
PF Fishpole Hoists Inc.

PF Fishpole Hoists are precision-engineered aircraft equipment maintenance hoists for single-attach point equipment installation and removal on all commercial aircraft:

- Valve engineered products.
- Short lead times.
- Speedy service at many locations worldwide.



FLUID MANAGEMENT
FluidTran Inc.

Custom-designer and manufacturer of fluid management and dispensing equipment introduces two new products: The advanced high-efficiency Heavy-Duty Cowl Pump/Thrust Reverser (shown); and Landing Gear Servicing Unit to improve safety, aircraft servicing efficiency and environmental performance. Company offers engineering design, prototyping, testing and manufacturing services to develop cost-effective equipment and system solutions for aircraft maintenance operations.

NATIONWIDE SERVICE

The Nation's Largest Equipment Service and Maintenance Provider

GARSITE

Aviation Refueling Equipment

- Maintenance Programs
- Fleet Management
- Compliance Inspections (ATA 103, NFPA, etc.)
- Equipment Repairs & Modifications
- All Makes and Models Serviced

Refuelers • Above Ground Fueling Systems • Parts

GARSITE

Aviation Refueling Equipment

1-888-GARSITE

427-7483

www.garsite.com



**RAPID DEPLOYMENT
AIRCRAFT JACK SET**
Malabar International

Malabar International has developed and produced a 320-ton Rapid Deployment Tripod Jack Set. Consisting of four 80-ton jacks, the portable aircraft jack set was developed to meet the need for emergency maintenance at airports without full-service facilities. When an aircraft requires

major repairs at a remote airport, the Rapid Deployment Set can be delivered on a wide-body PAX or freighter aircraft to facilitate quick repairs. The four ready-to-use tripod jacks are neatly packed on two standard 96-inch x 125-inch air cargo pallets. The jacks can be rapidly deployed and configured for a specific aircraft at the job site. The jack set is suitable for most Airbus and Boeing aircraft.



ABSORBENT MAT
New Pig Corporation

New Pig Corporation's PIG® Grippy® Mat features a one-of-a-kind adhesive bottom *that stays put, no matter what™*. It soaks up leaks and drips without bunching up, curling or sliding, and peels up easily.

**Rely on
Reelcraft™**

- Built to your exact needs
 - Rugged, durable
 - Trouble-free performance
 - API 1529 compliant*
- *Available upon request

New! Grounding Reels
Hi vis cable Series G 3000



Heavy duty single wrap hose reels

Made in USA

Rugged reels for:

- ✓ Aircraft refueling
- ✓ Air vent ducts
- ✓ Above ground refueling
- ✓ Hydrant refueling
- ✓ Deicing
- ✓ Static discharge

Refueling Hose Reels
Nordic Series
1" through 4" I.D. hose



www.reelcraft.com | 800-444-3134



PORTABLE HOISTS
Didsbury Engineering Co. Ltd.

Portable hoists for aircraft assembly/maintenance. Didsbury hoists have been in use in the aviation industry for more than 70 years. Used around the world for removal and installation of APUs, actuators, engines, landing gear, air-conditioning units and ram air turbines.



BATTERY DE-MISTER & DE-SULFATER
Thermoil Batteries

ThermOil® Battery De-Mister® and Battery De-Sulfater additives make running and maintaining ground support equipment easier and more cost-effective by decreasing maintenance costs and increasing the lifespan of batteries up to three times longer. Guaranteed. Thermoil Inc. manufactures and markets the products Battery De-Mister & Battery De-Sulfater. These products will increase battery life, reduce charge time, eliminate corrosion, greatly reduce water consumption, explosion, toxic fumes and will help to keep your battery working under any condition while providing a safer working environment.



CRUSH-PROOF LAVATORY DUMP HOSE
U.S. Airmotive GSE

The crush-proof lavatory dump hose from U.S. Airmotive GSE features 100 percent urethane hose wall with helix to protect hose (no wire); triple urethane cuffs; UV-resistant; bending radius 4 inches; translucent blue; available in many lengths.



NO-SPILL SYSTEMS
No-Spill Systems Inc.

Since 1986, Femco No-Spill™ Systems has set the bar for developing and producing high quality fluid draining systems. Femco No-Spill™ Systems provides premium drain plugs designed to make oil changes quick, easy, clean, and efficient. With dedicated dealers worldwide, Femco No-Spill™ Systems offers a wide range of products for heavy-duty trucks, passenger vehicles, buses, as well as agriculture, light-duty trucks, construction and heavy equipment.

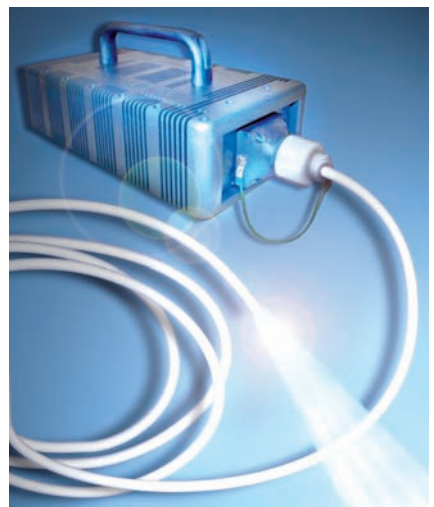

EXPLOSION-PROOF LIGHTING
Advanced Technologies, Inc.

Explosion-proof portable lighting equipment for hazardous and confined space areas. Ideal for fuel cell inspection and maintenance. Brilliant white light at 5700 (K) degrees color temp, 3100 Lumens emitted via fiber optic cables.

GROUND SUPPORT CORP. PRODUCTS

one stop shop

tel (860)491-3348

P.O. Box 232 Goshen, CT 06756

fax (860)491-9460

www.groundsupportproducts.com

CYGNUS
AVIATION
EXPO



SAE 2012

AEROSPACE AND DEFENSE

GROUND SUPPORT EQUIPMENT CONFERENCE

SAE INTERNATIONAL and CYGNUS AVIATION EXPO

TEAM UP FOR THE **MOST POWERFUL**
AVIATION EVENT OF 2012



MUST-ATTEND AVIATION EVENT

MARCH 7-9, 2012
LAS VEGAS CONVENTION CENTER

WWW.SAE.ORG/EVENTS/ADG
WWW.CYGNUSAVIATIONEXPO.COM

CYGNUS
AVIATION
EXPO

SAE International®



FUEL TANK INSPECTION
Rhine Air Inc.

Rhine Air manufactures portable aircraft fuel tank ventilation systems and supply air respiratory

protection equipment for fuel tank inspection and maintenance operations. Reduce maintenance turn times while creating a safer working environment.



AVIOXYCART
American Airworks

AviOxyCart for servicing oxygen cylinders on aircraft, on the tarmac and in the hangar.



WEIGHTED SPILL TRAY
Andax Industries LLC

The Weighted Spill Tray™ is a reusable, portable leak-containment tray with sealed-in weights to anchor it where it's placed. Includes a replaceable, oil-selective pad. Use in outdoor, windy environments where most spill pads blow away.



CONTIRV20
Continental Tire

The ContiRV20 is the first industrial tire developed specifically for aviation ground support equipment. Featuring dual-steel belt construction, reinforced sidewalls, low rolling resistance and low heat generation, the ContiRV20 has reduced one major airline's tire replacement and maintenance by more than 80 percent.

We Lead the Industry in Innovation

New!



GRV Glycol Recovery Vehicle
750, 1300, 2100 gallon options

Orion Deicer
880 gallons
47 Foot working height
10 minute heat time

New!



Learn about the latest from Global Ground Support, and how these new products save you time and money.

2200 XR 57 Foot working height
NO stabilizers

New!



Training Simulator - Deicing

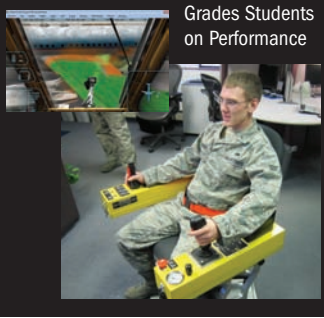

Grades Students on Performance

ISO 9001:2008-certified quality management system



540 East 56 HWY
Olathe, KS 66061-4640 USA
(913) 780-0300 www.globalgroundsupport.com



GSE SPECIALISTS
Carolina GSE Inc.

We buy and sell GSE, aircraft tooling, GSE parts and aircraft parts.

Passenger Stairs/ Lifts/Boarding Bridges

CONNECT
TO EACH MANUFACTURER
aviationpros.com/magazine/gsm/einquiry



TOWABLE PASSENGER STAIR Clyde Machines Inc.

The Model 15F2820 Towable Passenger Stair has a platform range of 88 feet by 161 feet. Upper platform size is a large 76 feet x 50 feet to allow the aircraft door to fully open when stair is in position. Other features: LED lighting with timer, onboard battery charger, battery level indicator. Optional solar-charging kit.



CANOPIES Estex Manufacturing Co. Inc.

Estex manufactures all styles of canopies with 12 years of proven service and reliability. Our tough dependable fabrics meet FAR25.853(b) and NFPA 415 & 417. We make bellows, hood and side curtain and inflatable canopies.



A380 PASSENGER BOARDING BRIDGE ThyssenKrupp Airport Systems

ThyssenKrupp Airport Systems Inc. manufactures state-of-the-art A380 Passenger Boarding Bridges. The ThyssenKrupp solution applies two, or more,

bridges at the lower and upper decks to service doors L1/L2 and U1. The A380 bridge is available in steel or glass.



Hydraulics International, Inc.

OXYGEN & NITROGEN SYSTEMS

Portable BOOSTER SYSTEMS designed for general aviation

Primary use for filling or topping off...

- Onboard Oxygen Bottle
- Underwater Breathing Apparatus (UBA)
- High Altitude High Opening (HAHO)
- Tires
- Accumulators
- Struts
- Escape Chute
- Life Rafts

Even if your cascade system pressure drops below 200-PSI

ELECTRIC DRIVEN SERIES 2G

Weight: 145-LBS
Dimensions: 32"L x 11.5"H x 20"D
Noise Level: 60-dBa
Double acting or 2-stage design uses no belts or pulleys



PNEUMATIC DRIVEN SERIES HIHPG3

Weight: 40-LBS
Dimensions: 20"L x 12.5"H x 11.5"D
Noise Level: 78-dBa



www.hiigroup.com

9201 Independence Ave., Chatsworth, CA 91311 USA

(Toll-Free) 888-780-7867

(Phone) 818-407-3400 (Fax) 818-407-3428



WHEELCHAIR LIFT
Uberlift

Uberlift safely lifts disabled passengers over the stairway of regional aircraft. When in the down position, the two-person lift provides crew and passengers clear walk through access to stairs, saving valuable turnaround time.



TOWABLE PASSENGER STAIRS
Wasp Inc.

WASP's Towable Passenger Stairs include models for Regional Aircraft (62-96" sill height), narrow-body aircraft (86-134" sill height), wide-body aircraft (132-160" sill height). Features: Morton® non-slip surfaces; 12V Lighting with Timer; ready-to-use towbar, moveable by hand; moveable platform handrails; auto-locking deck stabilizer; hydraulic stair stabilizer; and optional canopy.



FULL GSE LINE
Phoenix Metal Products

Manufacturer of a large line of GSE equipment, from small lavatory and water carts to 1,000-gallon trucks. Passenger stairs from RJ to A340 truck-mounted. Baggage loader and aircraft maintenance lifts.

Not just a... tug
It's a... **LEKTRO** Since 1945
www.lektro.com • sales@lektro.com

LEKTRO
The ultimate aircraft tug...

800-535-8767
503-861-2288
1190 S.E. Flightline Drive
Warrenton, Oregon 97146 USA

www.juniper-liverpool.com

Pictured: Steve Marshall with the GENx long probe.

Bottom left: The GE90-115B long probe in position on an Ethiopian Airlines Boeing 777-200 aircraft.

Check website for full probe & accessory list.

Juniper long engine wash probes

Cutting your engine wash times by up to an hour. It makes sense.

Tel: +44(0)151 733 1553
Email: gse@juniper-liverpool.com

Pushbacks/Tractors/ Utility Vehicles

**CONNECT
TO EACH MANUFACTURER**
aviationpros.com/magazine/gsm/einquiry



'FLEETRENU' PROGRAM A&V Rebuilding, Inc.

A&V's "FleetRenu" program offers customers frame up remanufactured tractors for a fraction of new cost. All tractors are built to customer specs and come with a full manufacturer's warranty. Many engine options available.



AIRCRAFT TOWING TRACTORS Douglas Equipment Ltd.

A complete range of towbarless and conventional aircraft towing tractors for handling all aircraft up to and including the A380, offering airlines and ground handling companies significant opportunities to reduce their operational costs and improve their operational efficiencies.



REMANUFACTURED ENGINES AND TRANSMISSIONS JASPER Engines & Transmissions

Remanufactured gas and diesel engines, transmissions and differentials for a variety of ground support equipment including pushbacks, people and baggage transportation and stationary power.

SIMPLY THE FINEST IN THE WORLD

- Value Engineered
- Extended Warranties
- Fast Service Turnaround

PF FISHPOLE HOISTS

SALES • SERVICE

1505 S. 93rd St, Unit BL, Seattle, WA 98106 USA
206.767.3887 • Fax 206.767.4006 • www.pffishpolehoists.com



EXPERTS
in GROUND SUPPORT
at **YOUR SERVICE**

Our New 28.5 VDC. Generator:

easier to use,
simple to maintain. **e28**
easy

The expression of knowledge
e-28: easy, strong, and eco-friendly

More Information:
305-888-0189 www.sgsequipment.com/e-28

Buy replacement parts for GSE
and get technical support
in the **SGS** online store



www.gsxp.com



LOW PROFILE TOW TRACTOR
NMC-Wollard Inc.

Low profile tow tractor with a DBP range from 25,000 to 48,000 pounds. 4WD/4WS with front wheel, crab, and coordinated steering. Powered by a Cummins diesel engine with powershift transmission and dual planetary reduction drive axles.



HERCULES
Harlan Global Manufacturing LLC

The Harlan Hercules is currently available in a 16,000- to 20,000-pound drawbar. Future line expansion will have these available in 12,000- to 25,000-pound drawbar. This heavy-duty unit is in use all over the globe and will take care of towing requirements for aircraft up to a B-737.



TOWBARLESS ELECTRIC AIRCRAFT TOWING VEHICLES
Lektro, Inc.

LEKTRO, Inc., manufactures towbarless electric aircraft towing vehicles. At the company's factory in Warrenton, Oregon. LEKTRO produces nine models of towbarless aircraft tugs, ranging in towing capacity from 28,000 to 180,000 pounds. Since inventing the towbarless concept in 1967, LEKTRO has remained the world's leading manufacturer of towbarless aircraft towing vehicles. As a testament to the reliability and durability of LEKTRO vehicles, you can find them in operation on nearly every continent around the globe.

DOUGLAS
Tugmasters

A complete range of
Towbarless and Conventional Aircraft Towing Tractors
 for handling aircraft up to the **Airbus A380**



DOUGLAS
 Power and Performance with Precision

Douglas Equipment Limited
 Douglas House, Village Road, Cheltenham, Gloucestershire GL51 0AB U.K.
 Telephone: +44 (0)1242 527921 Facsimile: +44 (0)1242 221198
 E-mail: sales@douglas-equipment.com WebSite: http://www.douglas-equipment.com

USA Office: Douglas Equipment International Inc.
 8305 Cherokee Blvd., Douglasville, Douglas County, Atlanta, Georgia 30134
 Telephone: 678 715 3003 Facsimile: 678 715 5563



The Secure P.C.A. Solution
 P.C.A. Hose Trolley



Rapid, Secure P.C.A. Deployment

- * Dramatically extends hose life by eliminating wear
- * Trolley keeps PCA hose secure 100% of the time
- * 100 % stainless steel construction = long life
- * 8' Sections allow for air cargo handling/shipping
- * Modular construction allows different configurations
- * Travels, retracts and secures to jetbridge



972-584-0551
 www.txmcs.com
 sales@txmcs.com

P.O. Box 8007 Greenville, TX 75404



THE WORLD OF AIR CARGO IS LANDING IN ATLANTA

26th International Air Cargo Forum & Exposition 2012

The Georgia World Congress Center - Atlanta, October 2-4, 2012



Over 5,000 delegates and visitors, more than 200 exhibitors and a world of networking and new business opportunities!
– RESERVE YOUR SPACE NOW!



Co-located with:
"The Supply Chain's Premier Event™"
Council of Supply Chain Management Professionals
Annual Global Conference 2012
September 30 – October 3, 2012

The world's premier air cargo industry event

Organized by



Hosted by





T137 HEAVY-DUTY TOW TRACTOR
Charlotte of America

This Charlotte tractor tows more than 20 tons. Charlotte has units in stock to help you meet upcoming environmental regulations.



WORLDWIDE GSE
SCHOPF
Maschinenbau GmbH

SCHOPF designs, manufactures and sells worldwide high-class GSE equipment for civil aviation and military deployments including a complete range of aircraft tow tractors between 5,000 and 70,000 kg operating weight, cargo equipment such as container/pallet loaders and

transporters as well as passenger stairs. Customers from more than 160 countries place their trust in the exceptional reputation for top quality and reliability, yet with low operating costs. More than 4,500 aircraft tow tractors have been sold worldwide.



EGSE CONVERSIONS
Electric Vehicles of America

Conversions are our business. eGSE conversions provide the best opportunity to reduce operating costs and ground level emissions. EVA can provide motors, controllers, battery chargers and more. Free engineering calculations.

A Pressure Sensitive Safety Edge For Passenger Boarding Bridges

For over 25 years, Tapeswitch Corporation has been the original equipment manufacturer of a switch edge system that provides sensing and detection for passenger boarding bridges.

Application 1: Detect other ground support vehicles and equipment **Part Number 4621/3650110.**

Application 2: Get even closer to the aircraft without damaging equipment and aircraft. **Part Number 4635/414538.**

Custom fit to all passenger boarding bridges. Available in many sizes and will cross reference part numbers.

UNION IUE-CWA LOCAL 463

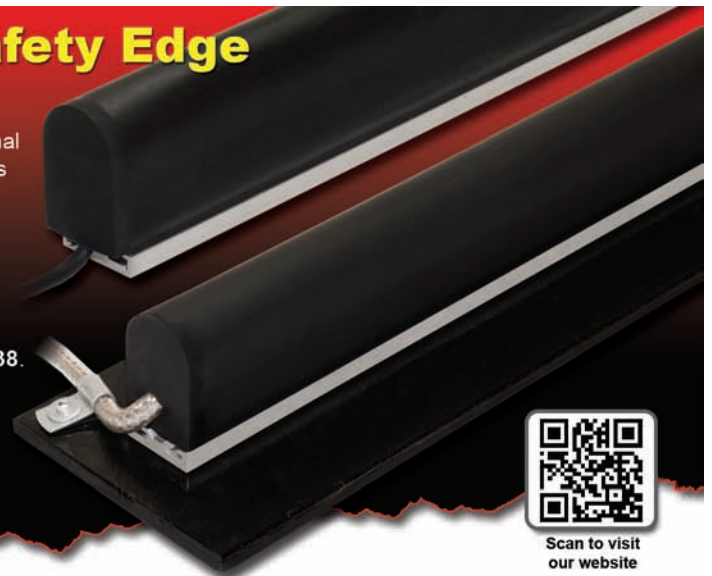

Scan to visit our website



Safety Switches
 Electrical pressure sensitive switch used for general purpose applications.



Safety Bumpers
 Electrical switch safety bumper. Connects to control logic. Custom fit to all ground support vehicles.



Safety Edges
 Electrical switch safety edge. Connects to control logic. Custom fit to cargo loaders, lifts, and passenger boarding bridges and all manufacturers' ground support vehicles and equipment.



1-800-234-8273

Think Safety. Plan Safety. Protect People.

WWW.TAPESWITCH.COM

Tapeswitch Corporation
 100 Schmitt Boulevard
 Farmingdale, New York 11735
 E-Mail: marketing@tapeswitch.com

Safety/Security/ Communications

**CONNECT
TO EACH MANUFACTURER**
aviationpros.com/magazine/gsm/einquiry



COOLING VESTS

Silver Eagle Outfitters Cooling Apparel

Silver Eagle Outfitters is the leading manufacturer of comfort apparel that emphasizes temperature regulation and sun protection. Available in high-visibility fabrics, Silver Eagle's cooling vests offer hours of evaporative cooling and immeasurable quality of design and fabric. Our microfiber apparel provides year-round, temperature-mitigating comfort and UV protection, and is ideal for wearing alone or beneath other garments.

PRESSURE-SENSITIVE SAFETY EDGE FOR PASSENGER BOARDING BRIDGES

Tapeswitch Corporation

Automated safety switch systems are connected to the passenger boarding bridge electronically and in two applications for the passenger boarding bridges, one from aircraft and another from other ground vehicles, which can provide sensing, detection, and collision avoidance. Tapeswitch Corporation is the original equipment manufacturer of these electronic switch edge systems for more than 50 years.

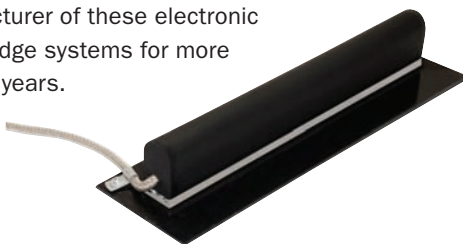

HIGH-VISIBILITY GEAR BAG Transportation Safety Apparel

In addition to reflective striping, these bags come with large blocks of high-visibility lime green fabric. And we carry them in styles for almost any profession.



MAC portable aircraft heaters. Built to perform. Built to last.

MAC 400HC Indirect Fired, Portable Heater (RJs & Narrow Body Aircraft)



- Three MAC heater models to choose from, ranging from 200,000 to 800,000 BTUs
- Effectively heats all types of aircraft in the coldest, most difficult conditions
- Replaces APUs for aircraft heating for substantial avoided fuel burn savings
- Simple to operate, environmentally friendly, safe, ruggedly dependable, very efficient



MAC Heaters - US Toll Free 1.800.272.4604

2106 East Indiana Avenue Bismarck, ND 58504
Phone +1 701.222.4328 Fax +1 701.751.4285

sales@macheaters.com • www.macheaters.com



AIRCRAFT SERVICE INTERNATIONAL GROUP™
Exceptional Service from the Ground Up!



Director of Sales Positions - Ground Handling and Passenger Service

Aircraft Service International Group, Inc. (ASIG), a leading international aviation service provider, corporate headquarters located in Orlando, FL, is seeking to increase its Sales Organization with two Directors of Sales. Preferred candidates will have commercial Ground Handling and/or Passenger Service sales or operation experience. Relocation to ASIG's offices in Orlando is not necessary (may work remotely). Highly competitive compensation package rewards sustaining valued existing accounts, exceeding customer expectations and earning the trust to service new customers and accounts.

If you have continuously delivered exceptional sales performance,
please apply at www.asig.com. ASIG is an EOE - M/F/ D/ V



PUSHBACK HEADSET
Comprehensive
Technical Solutions

Introducing the ProMod M2 by CTS, our newest Pushback Headset featuring an ear cup PTT and high-quality swivel microphone. Classic styling at a budget friendly price of only \$178.



RAMP MANAGEMENT SOLUTIONS

Safegate Airport Systems Inc.

Safegate's ramp management solutions are built around the Safedock™ advanced visual docking guidance system and gate-operating technology that links all gates and integrates with airport and airline systems to provide real-time gate intelligence and shared data that can be used to improve efficiency, safety and overall performance on the ramp.



9900 WIRELESS COMMUNICATION SYSTEM

David Clark Company Inc.

David Clark Company's quality-built headset communication equipment provides clear communications and hearing protection during pushback, deicing and maintenance operations. Our 9900 Wireless Communication System provides maximum mobility and improved safety during ground support operations.

Hall Industries, Inc

Providing complete GSE Technical Services to support airline ground support equipment including: belt loaders, pushback tractors, baggage tractors and carts as well as baggage handling systems, passenger boarding bridges, potable water units, ground power units and lavatory service vehicles.

www.hallindustries.com • 724-752-2000

Spare parts for GSE, automotive, truck, and industrial applications

AVIATION PARTS TOTAL and SERVICES, LLC

Phone: 860-658-1377 Fax: 860-658-2209
 E-mail: sales@totalaviationparts.com
 International Sales Reps. Positions Available

Setting The Standard Of Excellence In Ground Support Equipment

- Hydraulic Jacks
- Hydraulic Power Units
- De-icer/Washers
- AC/DC Cables
- Fluid Dispensers
- Engine Stands and Trailers
- Maintenance Stands
- Towbars
- Cable Plugs - AC/DC
- Hydraulic Couplings

Mc Dermott Associates, Inc.
 11424 Denton Drive
 PO Box 29617
 Dallas, TX 75229-0617
PHONE: 972-247-7146
FAX: 972-247-7171
jetmac1@aol.com

PLACE YOUR AD HERE

Contact Kimberly Jorgensen for information:
920-568-8307
Kimberly@AviationPros.com

HYDRO POWER
 DOORS BY SCHWEISS

- FARM DOORS
- HANGAR DOORS
- INDUSTRIAL DOORS

NOW MANUFACTURING HYDRAULIC DOORS

Schweiss Does it Better!
 Visit Us At **800-746-8273**
SchweissDoors.com



FORTBRAND

SERVICES INC

www.fortbrand.com

516 576-3200

fax 516 576-3221

info@fortbrand.com

SALES RENTALS LEASING FINANCE CONSULTING

<p>AIRCRAFT TOW TRACTORS</p> <p>TLD TMX-150, closed cab (35,000 lbs GVW)</p> <p>Equitech B-250 (25,000 lbs GVW)</p> <p>Eagle TT-12 (12,000 lbs DBP)</p> <p>CARGO LOADERS</p> <p>FMC Commander 30</p>	<p>HEATERS</p> <p>Air-A-Plane 5050, diesel</p> <p>BAGGAGE TRACTORS</p> <p>Tug MA50, gas</p> <p>Tug MA50, electric</p> <p>Harlan HTC 50, gas</p> <p>DEICERS</p> <p>Premier MT43P21, open bucket</p> <p>Premier MT43D15, forced air</p> <p>Global 2100, forced air</p> <p>Trump D2-40, open bucket</p>	<p>GPU</p> <p>TLD 90KVA, 120KVA + 140KVA</p> <p>Hobart Jet Ex5D 28V</p> <p>CONVEYORS</p> <p>NMC- Wollard TC-888, diesel</p> <p>SOLID STATE CONVERTERS</p> <p>FCX 30 Kva output</p> <p>Hobart 90Kva/28V dual output</p> <p>AIR CONDITIONERS</p> <p>TLD 802 - 110 ton w/heat</p> <p>TLD 302 - 30 ton w/heat</p> <p>Air-A-Plane 1520 - 20 ton</p>	<p>PASSENGER STAIRS</p> <p>Phoenix Metal PAS200 wide body</p> <p>Stinar SPS-2513 narrow body</p> <p>REFUELERS</p> <p>1,200 gallon GSE refuelers</p> <p>Par-Kan 600 gallon trailer (gas + diesel)</p> <p>TOWBARS</p> <p>ERJ 145</p> <p>LAVATORY TRUCK</p> <p>Phoenix Metal TL600 widebody</p>
--	---	--	--

FOR SALE OR LEASE

28 VOLT DC POWER CART

MSR-600-28



CURRENT POWER

Phone: 203-994-8408 • Fax: 203-403-9543
Email: sales@currentpower.biz • www.currentpower.biz

When you advertise in
Ground Support Worldwide...

THE SKY IS
THE LIMIT!

Contact Kimberly Jorgensen
for more information:
920-568-8307
Kimberly@AviationPros.com

MERCURY
GSE

www.mercurygse.com

for current stock of air starts,
bag tugs, beltloaders, bobtails,
crew and passenger stairs, gpu's,
loaders — main and lower deck,
tow tractors and other items.

SALES LEASE RENTAL APPRAISAL

WE BUY SURPLUS GSE

PH: (562) 653-0654 FAX: (562) 653-0665
E-MAIL: dtaylor@mercurygse.com
12519 Cerise Ave., Hawthorne, CA 90250

ADVERTISE HERE

Contact Kimberly Jorgensen
for more information:
920-568-8307
Kimberly@AviationPros.com

JACKS 3 Ton to 100 Ton
B-1, B-2, B-4, and B-5 Work Stands,
Wheel & Brake Dollies, tow Bars,
Engine Cranes, Engine Stands, etc.
Overhauled, Reconditioned like New

AIRCRAFT PARTS &
GROUND SUPPORT EQUIPMENT, INC.

Tel: 305-871-2192
Fax: 305-871-6081



IT PAYS
TO ADVERTISE

Contact Kimberly Jorgensen for info:
920-568-8307Kimberly@Aviation-Pros.com



ProMod M2

Push-Back
Headset

\$178.00

Comprehensive Technical Solutions, Inc.
1 Bank St. Orchard Park, NY 14127
(716)667-2714 www.promodgse.com

DAVIN Inc.

FOR SALE OR LEASE

AIRC CONDITIONERS

1991 ACE, Model 802-620, F600 mounted 110-ton unit

AIR START UNIT

1998 Trilectron, Model PSC1800, 180 PPM, 8V92 DDEC.

BAGGAGE/CARGO TOW TRACTORS

1995 Harlan, HTAB-40, Cummins diesel w/cab.
(6) 2003 Harlan, HTAG-80 Ford 6-cyl 8K DBP.
1997 Toyota, 02-TD-23 diesel.
2008 NMC-Wollard, Model 60DCC6-6K w/cab.
2005 Toyota, 02-2TG-23, LP-Gas engine w/cab.
2006 Tug, MA-50, Ford 6-cyl, LP-Gas w/cab.
1998 Tug, MA-30, Ford 6-cyl LP-Gas w/cab.

DEICERS

(2) 2002 Premier, Model MT43D15 deicers w/enclosed basket.

GROUND POWER UNITS

2005 Hobart 120CU24P5, 120 KVA
2008 TLD, Model GPU4090-T-CUP, 90 KVA
1992 Hobart, Model 90J20P, 90 KVA (2 available)

PASSENGER STAIRS

2001 Stinar, Model SPS-3518 GMC diesel 96" to 228"
1997 Stinar, Model SPS-2513, Ford F250, 84" to 145"
1990 NMC-Wollard, Model TLPH-252 F350 100" to 200"

PUSHBACK TRACTORS

1982 United, SML-80 low profile, JD diesel, 8K DBP.
1996 NMC-Wollard, Model 140, Perkins diesel, 10K DBP. (4 avail)
2002 NMC-Wollard, Model 200, Cummins diesel, 20K DBP.
1996 S&S, Model GT-35, Deutz diesel, 30K GVW, 24K DBP.
2007 FMC Model B400 Deutz, 4ws, w/cab 35K GVW.
2010 JBT, Model B1200 Cummins Diesel, w/cab 100K GVW

SALES, LEASING, FINANCING

631/499-6363
Fax: 631/499-4222
www.davin-inc.com



SAFETY CORNER BUMPERS LogicAir Group Inc.

LogicAir is offering new Safety Corner Bumpers in high-visibility orange. Air cushion chamber. Available in 10-foot or 6-foot sizes. Open wind for easy installation. Available also in white. LogicAir is a leader in general aviation and GSE supplies. With a strong presence in the Caribbean and Latin-America, general distributor and manufacturer for ramp security, cleaning, GSE equipment and parts and accessories, tooling and general on-board supplies. Worldwide exporters, absolute customer service, hablamos español.



WINGWALKER Conney Safety

The WingWalker™ is a wireless collision avoidance safety system that prevents accidents during pushback operations by providing advanced warning to tug operators. It will improve your safety performance benchmarks while avoiding costly downtime and repairs from avoidable collisions. Most importantly, the WingWalker™ Safety Management System (SMS) easily integrates with your existing business practices.



WIRELESS GROUND SUPPORT Flightcom Corporation

Flightcom supports hundreds of thousands of commercial and military flight crews and ground support personnel with communication systems that deliver clear communication, even under the most challenging circumstances. Its wireless ground support systems keep aviation and ground crews safe, effective and productive during aircraft ground pushback, marshalling, maintenance, and de-icing operations.



MICRO SYSTEM GROUND SUPPORT HEADSET Lynx Avionics Ltd.

An integrated headset and communication adapter providing simultaneous connections to an aircraft intercom, hand-held radio and cellphone. Uses standard interchangeable radio leads and telephone leads or a Bluetooth telephone connection.



MOBILE LOGBOOK Aviation Core Matrix LLC

Why would you keep a log of your activities?

- Safety
- Security
- Regulatory compliance
- Proof of competency
- Better job opportunities
- Audits
- OJT records
- Tracking useful data

Utilize the many features of Aviation Skills Matrix to centralize all of your work experience, training, and skill history on our web-based service, and now include daily activities with the new mobile logbook app!



WHEEL CHOCKS Checkers Industrial Safety Products

TIGERCHOCKS™ provide state-of-the-art wheel chocks for military, commercial, and general aviation. Made of high-visibility urethane, durable material withstands weather, fuel spills, and never needs painting.

Nobody NOSE Ground Support Like Par-Kan



Luggage



Potable Water



Refuse



Lav Service



Fueling



Lav Service

Your industry demands quality, versatility, and most of all, dependable products that make you a leader in today's competitive world.

Par-Kan knows that your customer's experience begins on the ground and what happens there assures them timely departures and arrivals.

Celebrating our 20th year in business, Par-Kan has developed its Ground Support Systems division into one of the best and most recognized complete ground support equipment lines in the industry.

The Par-Kan line consists of 20 towable carts in the following categories for all your specific needs.

- **Baggage • Potable Water**
- **Lav Service • Fueling • Refuse**
- **Cargo Trailers**

Par-Kan Company constantly strives to satisfy your requirements by providing the professional service, quality, value and performance that you can depend upon and trust.

Call today for our complete support line



Ground Support Systems

800-291-5487 • www.par-kan.com
Silver Lake, Indiana • fax (260)352-0701
gseales@par-kan.com



GLOBAL LEADERS IN AVIATION REFUELING EQUIPMENT



LIQUIP INTERNATIONAL USA
1209 Freeway Drive
Reidsville NC 27320
Tollfree 1877-4-LIQUIP
Outside US +1 336 342 0306



LIQUIP INTERNATIONAL
602-606 Somerville Rd
Sunshine West VIC 3020
Phone +61 3 8311 6600



ALMAC TANK INTERNATIONAL
1, rue Pinat
Lanoraie, QC
Canada J0K 1E0



ALMAC EUROPE
Z.A La Gravière,
Chemin de la gravière Lot 5
01480 Fareins, France